

Sistema de Arquivos

Sistema de Arquivos

- Armazenam grande quantidade de informação
- Dados deve ser persistentes (não-voláteis)
- Acesso à informação pode ser concorrente

Nomes e extensões

Extension	Meaning
file.bak	Backup file
file.c	C source program
file.gif	CompuServe Graphical Interchange Format image
file.hlp	Help file
file.html	World Wide Web HyperText Markup Language document
file.jpg	Still picture encoded with the JPEG standard
file.mp3	Music encoded in MPEG layer 3 audio format
file.mpg	Movie encoded with the MPEG standard
file.o	Object file (compiler output, not yet linked)
file.pdf	Portable Document Format file
file.ps	PostScript file
file.tex	Input for the TEX formatting program
file.txt	General text file
file.zip	Compressed archive

Estrutura de arquivos

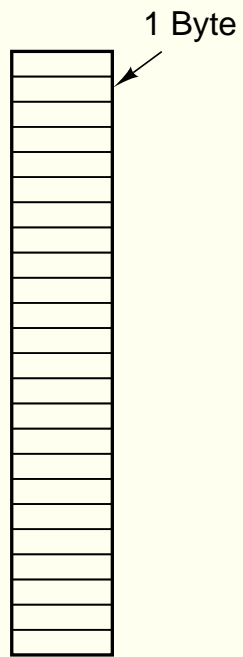

(a)

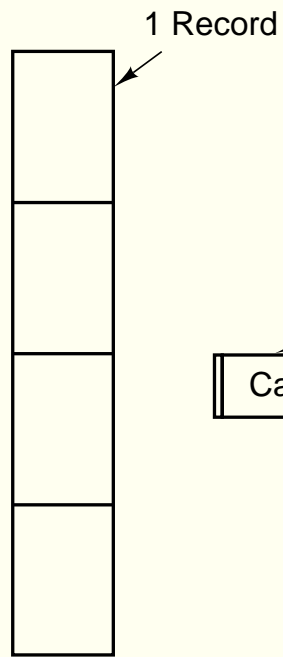

(b)

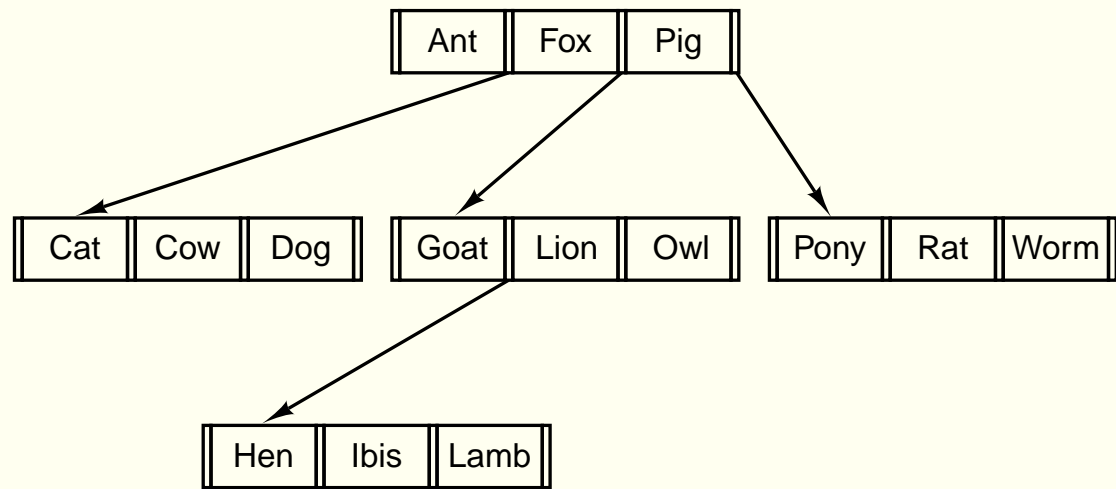

(c)

Tipos de arquivos

- regulares
- diretórios
- caracter
 - terminais, impressoras e rede
- bloco
 - discos

Tipos de arquivos

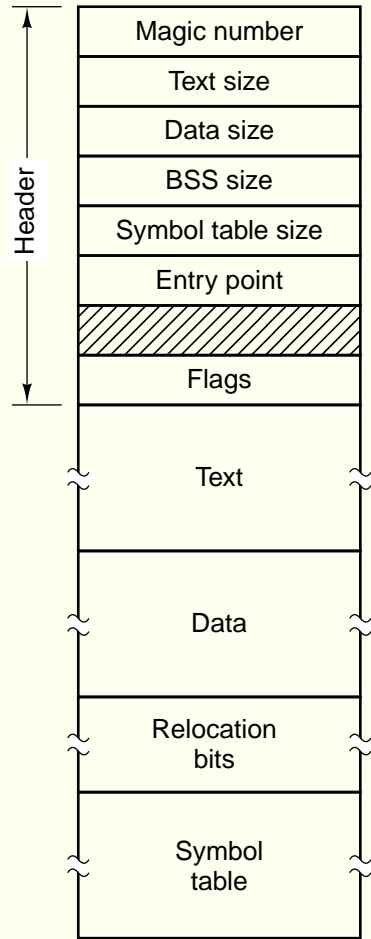

(a)

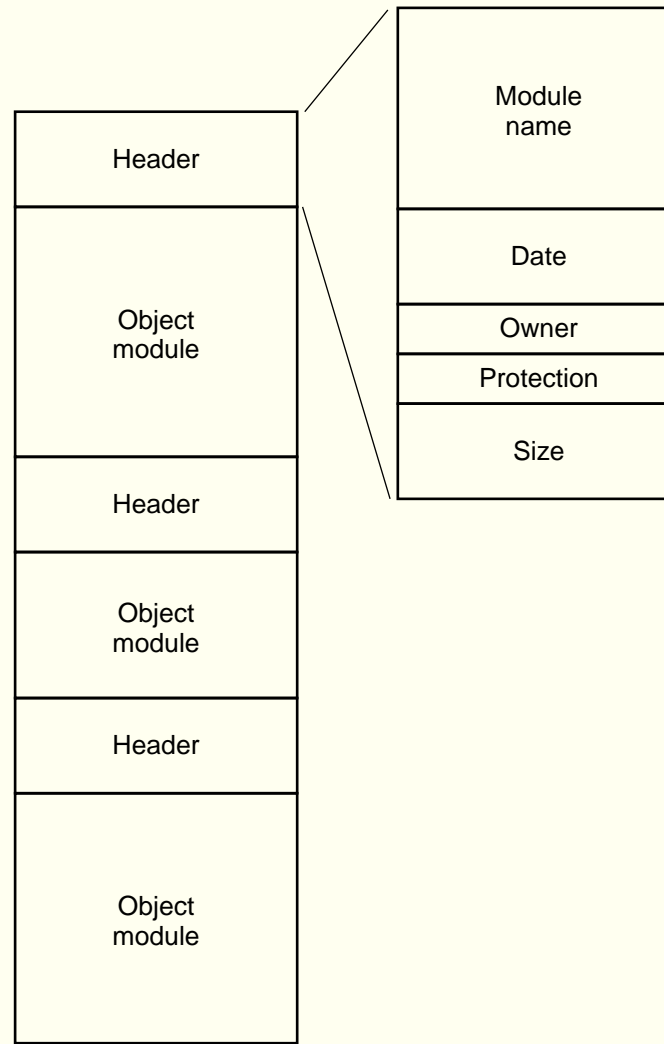

(b)

Acesso a arquivos

- Seqüencial
 - Lê todos os bytes a partir do início
 - Fitas magnéticas
- Aleatório
 - Bytes podem ser lidos em qualquer ordem
 - Bancos de dados

Atributos de arquivos

Attribute	Meaning
Protection	Who can access the file and in what way
Password	Password needed to access the file
Creator	ID of the person who created the file
Owner	Current owner
Read-only flag	0 for read/write; 1 for read only
Hidden flag	0 for normal; 1 for do not display in listings
System flag	0 for normal files; 1 for system file
Archive flag	0 for has been backed up; 1 for needs to be backed up
ASCII/binary flag	0 for ASCII file; 1 for binary file
Random access flag	0 for sequential access only; 1 for random access
Temporary flag	0 for normal; 1 for delete file on process exit
Lock flags	0 for unlocked; nonzero for locked
Record length	Number of bytes in a record
Key position	Offset of the key within each record
Key length	Number of bytes in the key field
Creation time	Date and time the file was created
Time of last access	Date and time the file was last accessed
Time of last change	Date and time the file has last changed
Current size	Number of bytes in the file
Maximum size	Number of bytes the file may grow to

Veja o comando stat

Operações sobre arquivos

- create
- delete
- open
- close
- read
- write
- append
- seek
- get attributes
- set attributes
- rename

Programa copy

```
#define BUF_SIZE 4096
#define OUTPUT_MODE 0700

int main(int argc, char *argv[]) {
    int in_fd, out_fd, rd_count, wt_count;
    char buffer[BUF_SIZE];

    if (argc!=3) exit(1);

    in_fd = open(argv[1], O_RDONLY);
    if (in_fd < 0) exit(2);

    out_fd = creat(argv[2], OUTPUT_MODE);
    if (out_fd < 0) exit(3);
```

Programa copy

```
while((rd_count = read(in_fd, buffer, BUF_SIZE)) > 0) {  
    wt_count = write(out_fd, buffer, rd_count);  
    if (wt_count <= 0) exit(4);  
}
```

```
close(in_fd);  
close(out_fd);
```

```
if (rd_count == 0) exit(0);  
else exit(5);  
}
```

Streams

```
int fprintf(FILE *stream, const char *format, ...);
```

```
int fscanf(FILE *stream, const char *format, ...);
```

```
FILE *fopen(const char *path, const char *mode);
```

```
int fclose(FILE *stream);
```

Arquivos mapeados em memória

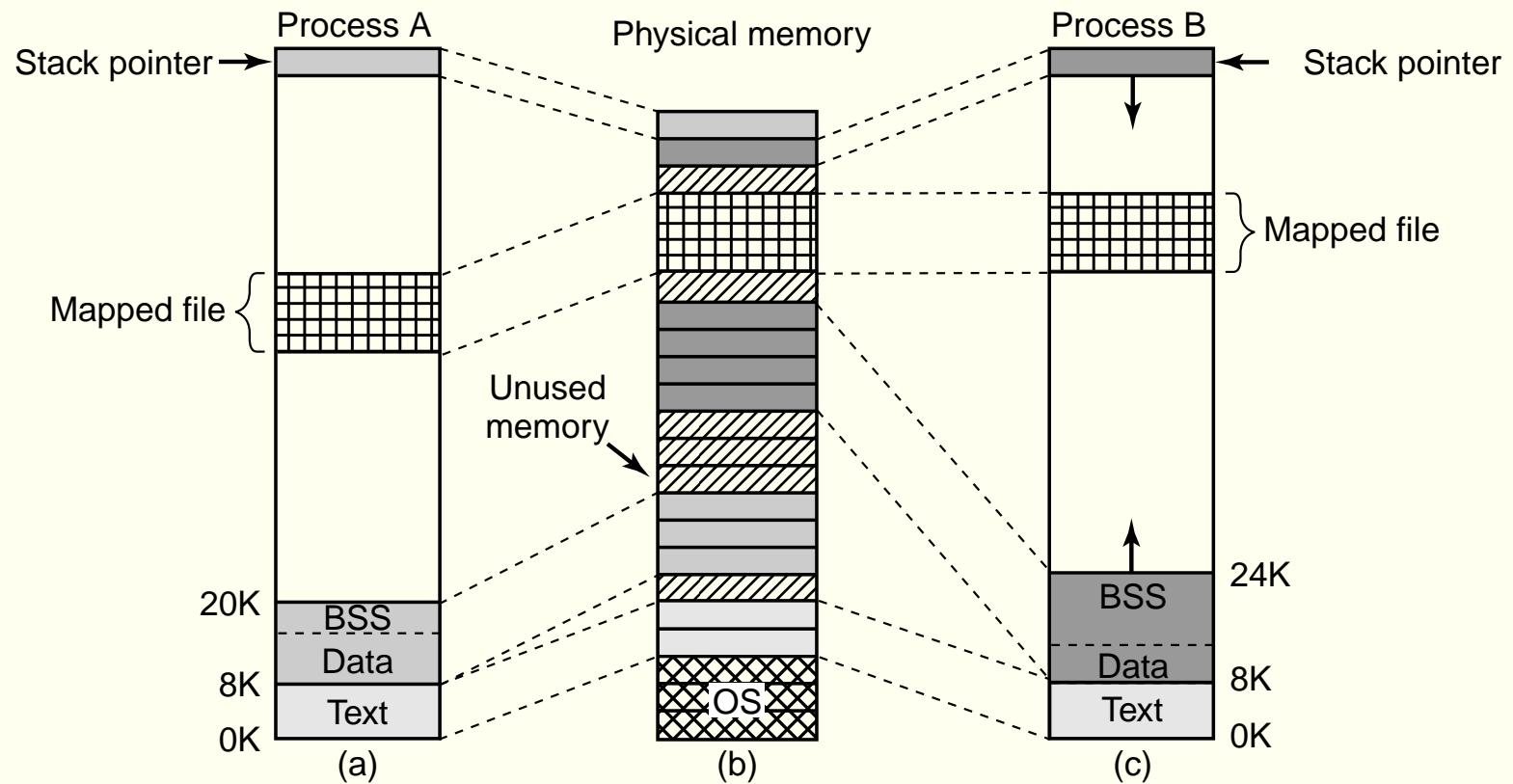

Mmap

```
void *mmap(void *start, size_t length, int prot,  
int flags, int fd, off_t offset);
```

- start: endereço preferencial na memória onde o arquivo pode ficar; NULL caso o sistema deva escolher.
- length: tamanho do mapeamento
- prot: PROT_EXEC, PROT_READ, PROT_WRITE, PROT_NONE
- flags: MAP_SHARED ou MAP_PRIVATE
- fd: file descriptor do arquivo a ser mapeado
- offset: deslocamento em relação ao início do arquivo

Diretórios

Nível único

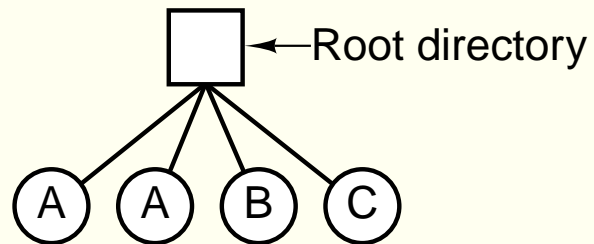

- 4 arquivos
- 3 proprietários: A, B e C

Diretórios

Dois níveis

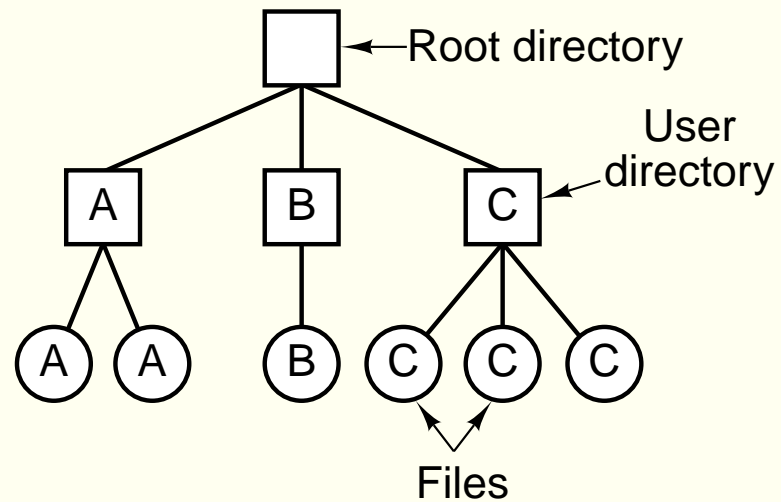

- Um diretório por usuário

Diretórios

Estrutura hierárquica

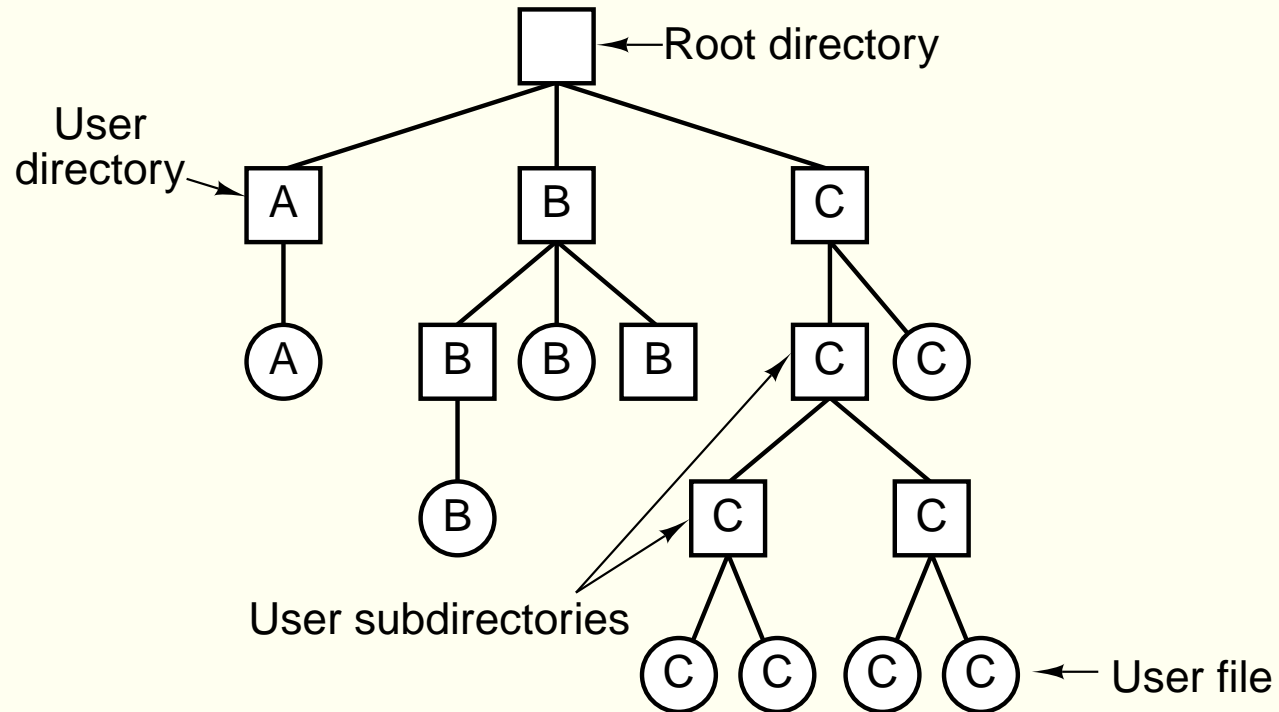

Caminhos

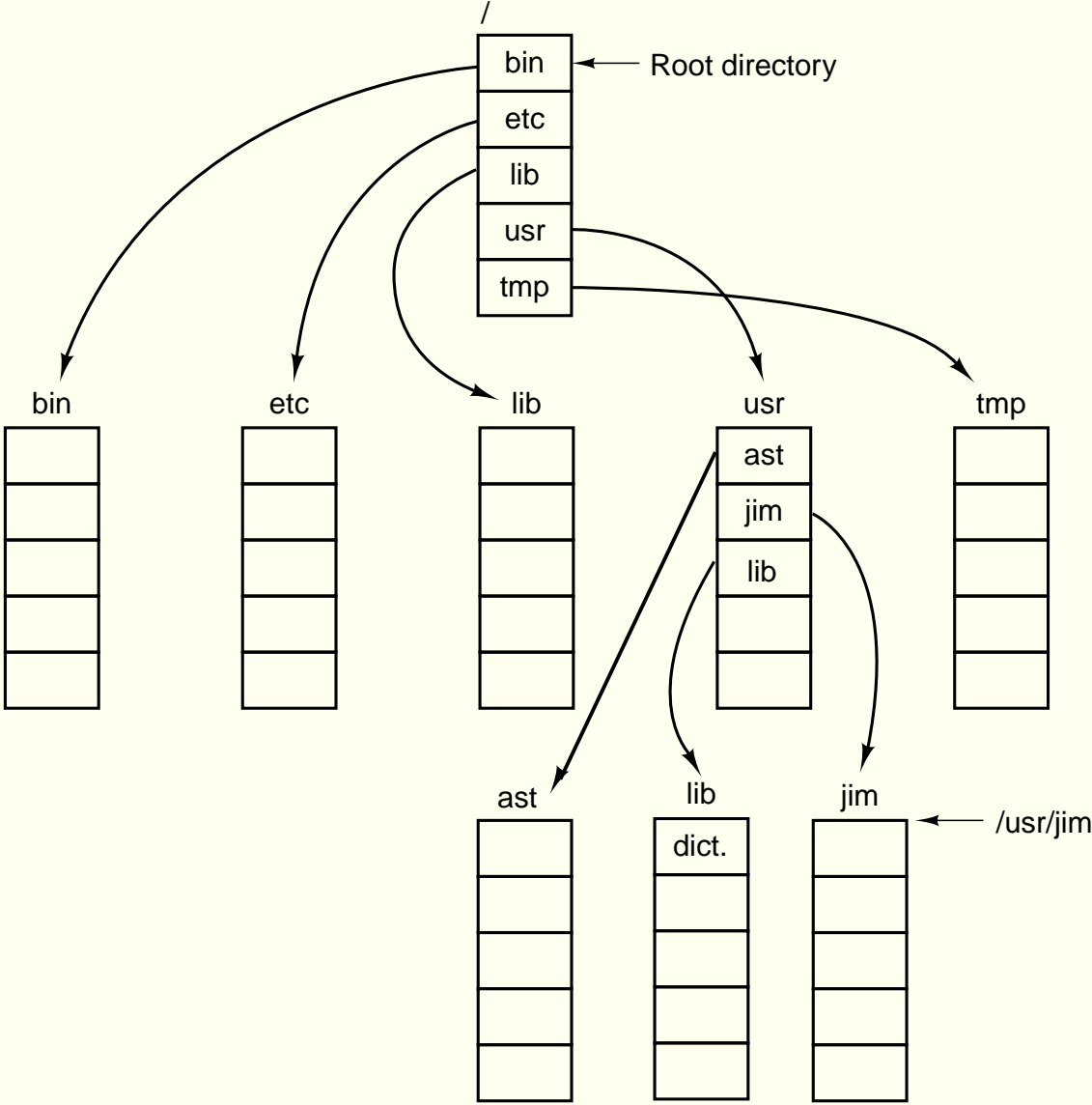

Mount

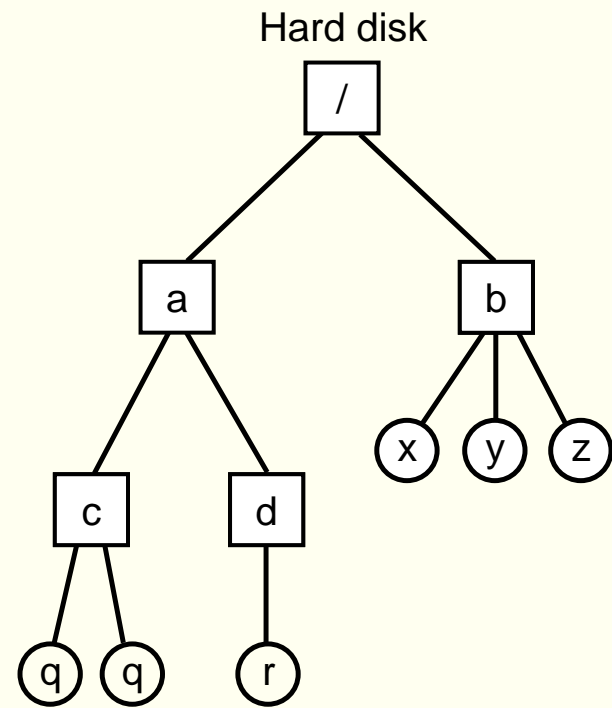
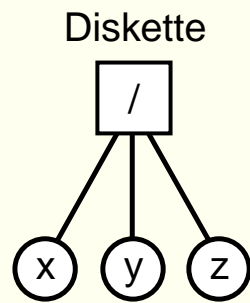
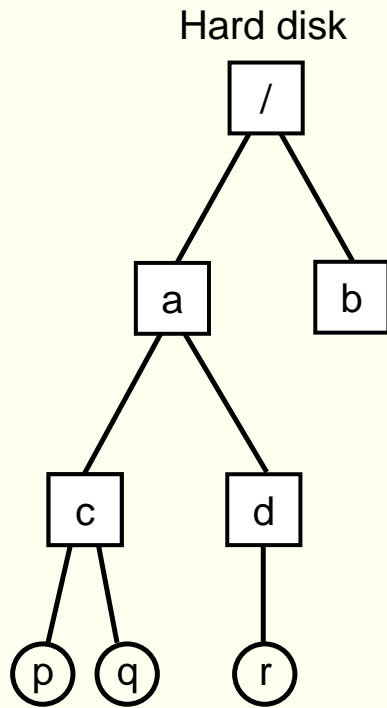

Operações sobre arquivos

- create
- delete
- opendir
- closedir
- readdir
- rename
- link
- unlink

Links

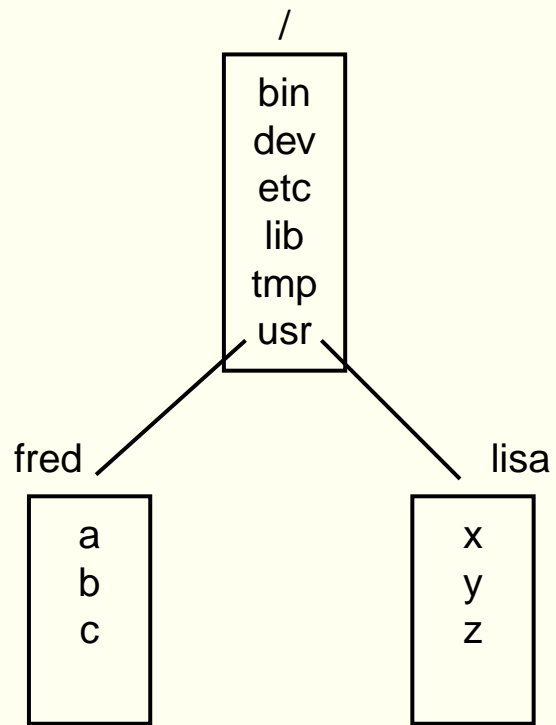

(a)

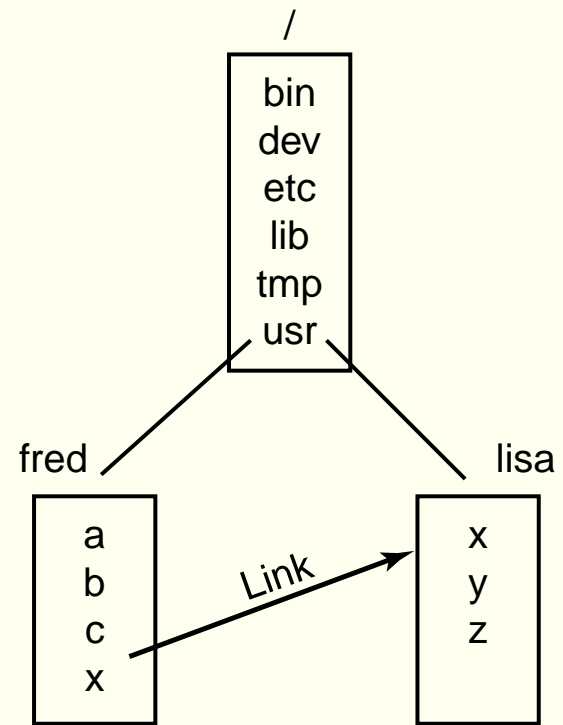

(b)

Questões de Implementação

- Como os arquivos são armazenados
- Como o espaço livre é gerenciado
- Eficiência
- Confiabilidade

Layout

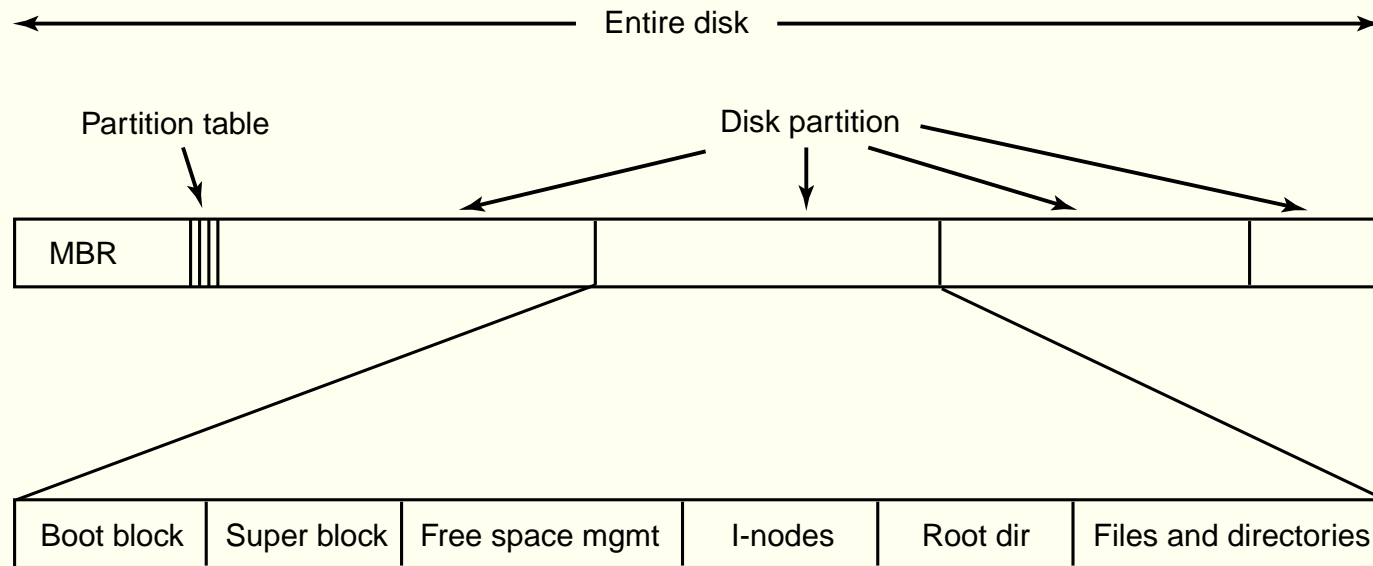

- MBR (Master Boot Record)
- Tabela de partições
- Boot block

Alocação contínua

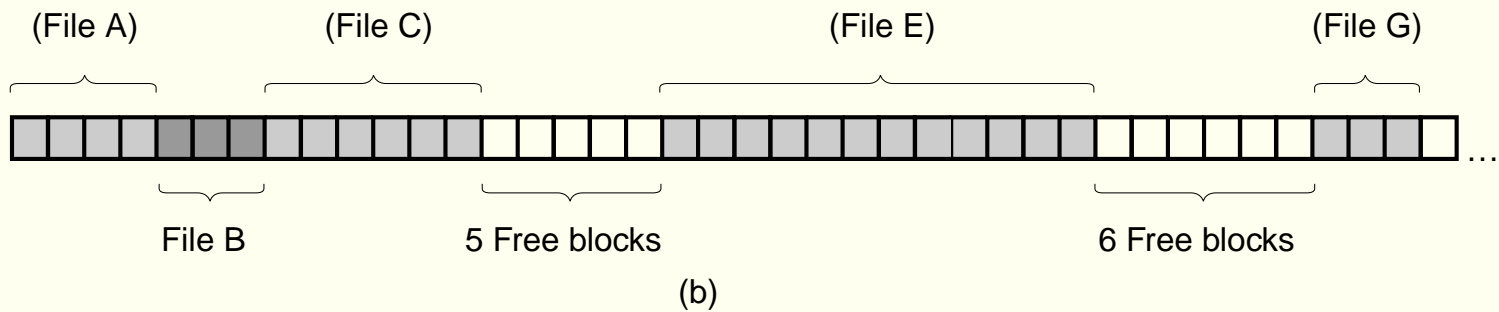
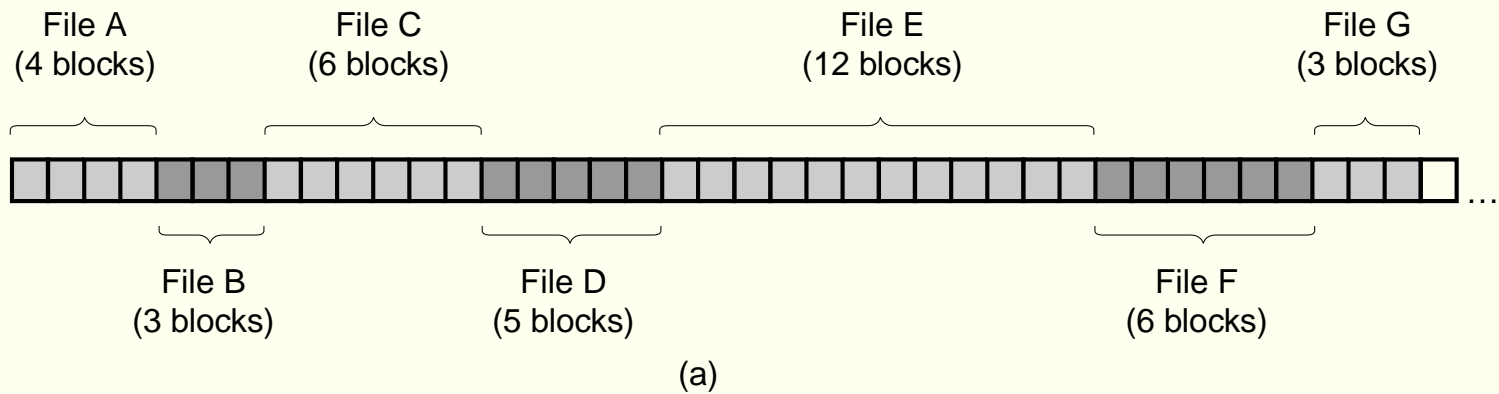

Compactação do disco

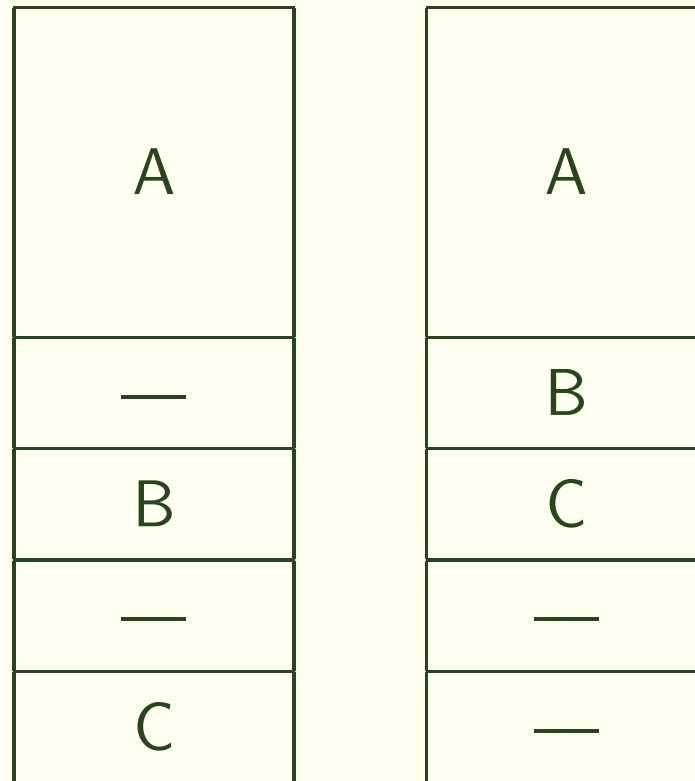

Lista ligada de blocos

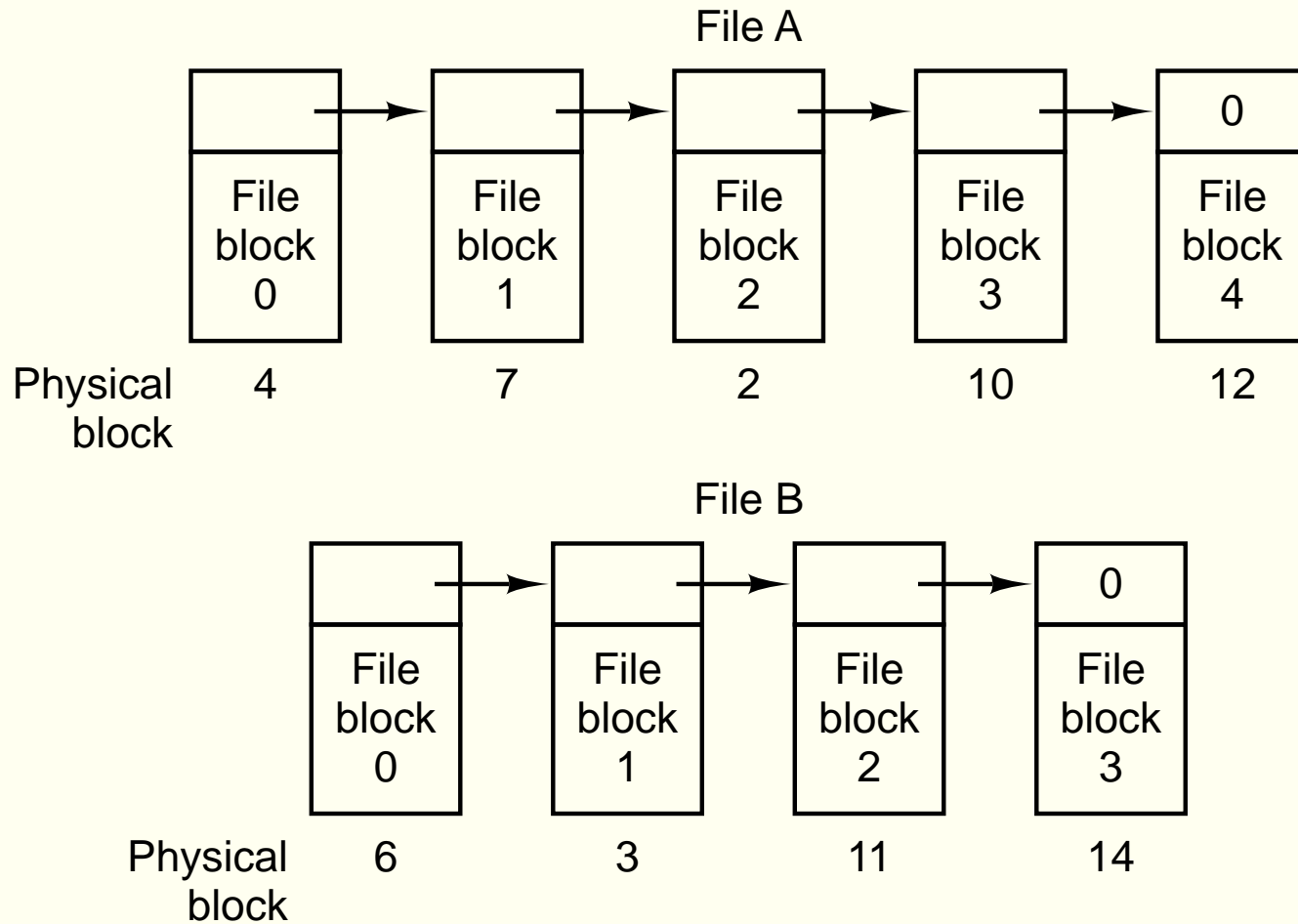

File Allocation Table (FAT)

Physical
block

0		
1		
2	10	
3	11	
4	7	← File A starts here
5		
6	3	← File B starts here
7	2	
8		
9		
10	12	
11	14	
12	-1	
13		
14	-1	
15		← Unused block

I-node

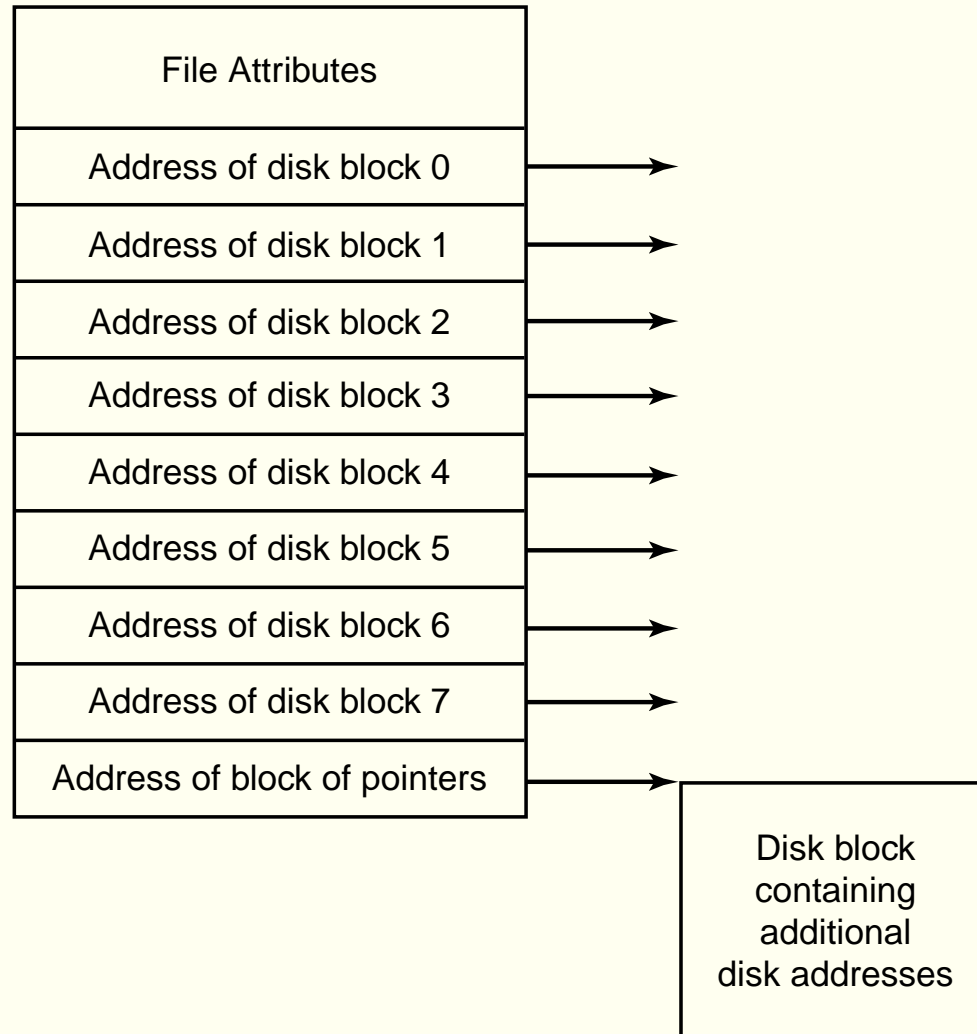

Implementação de diretórios

games	attributes
mail	attributes
news	attributes
work	attributes

(a)

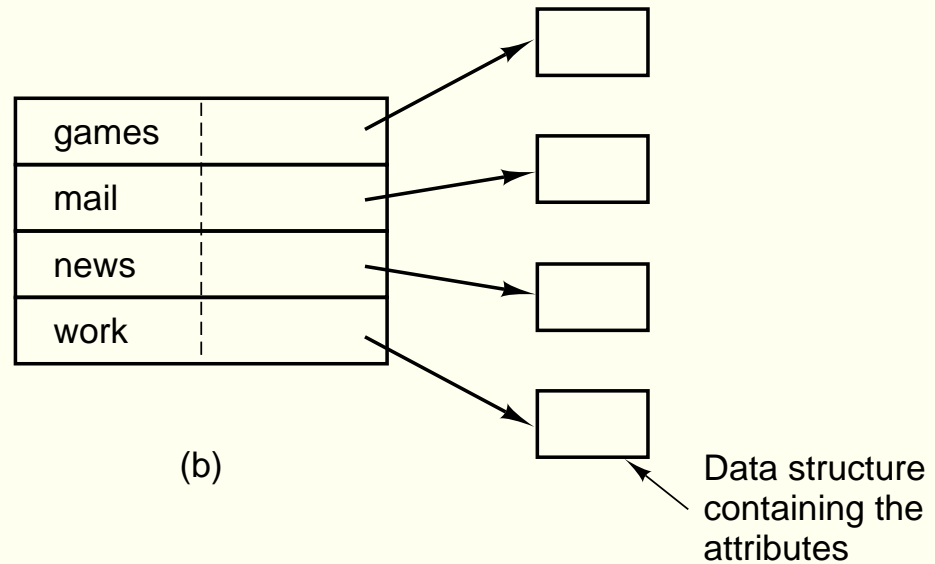

(b)

Nomes de tamanho variável

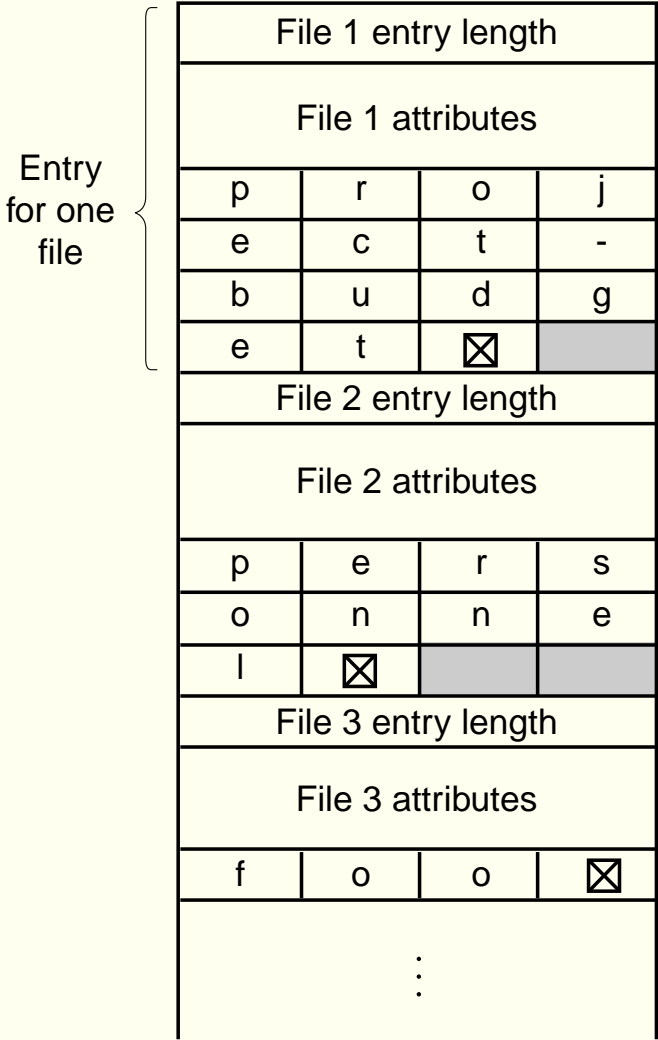

(a)

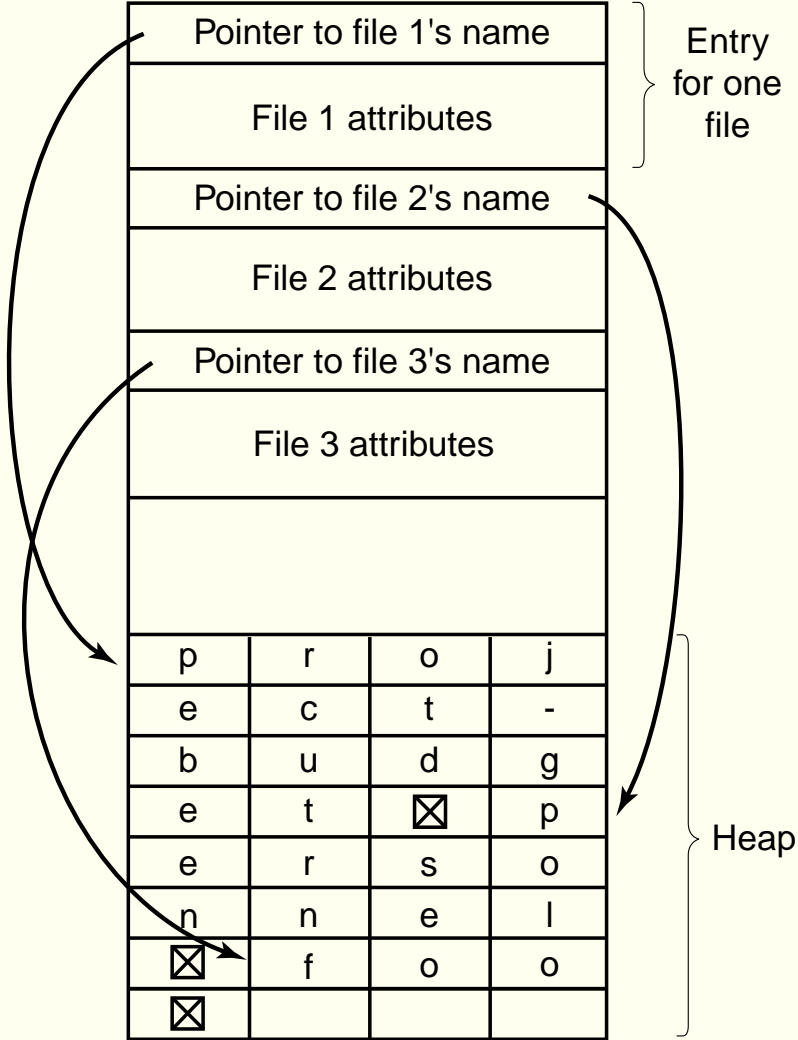

(b)

Arquivos compartilhados

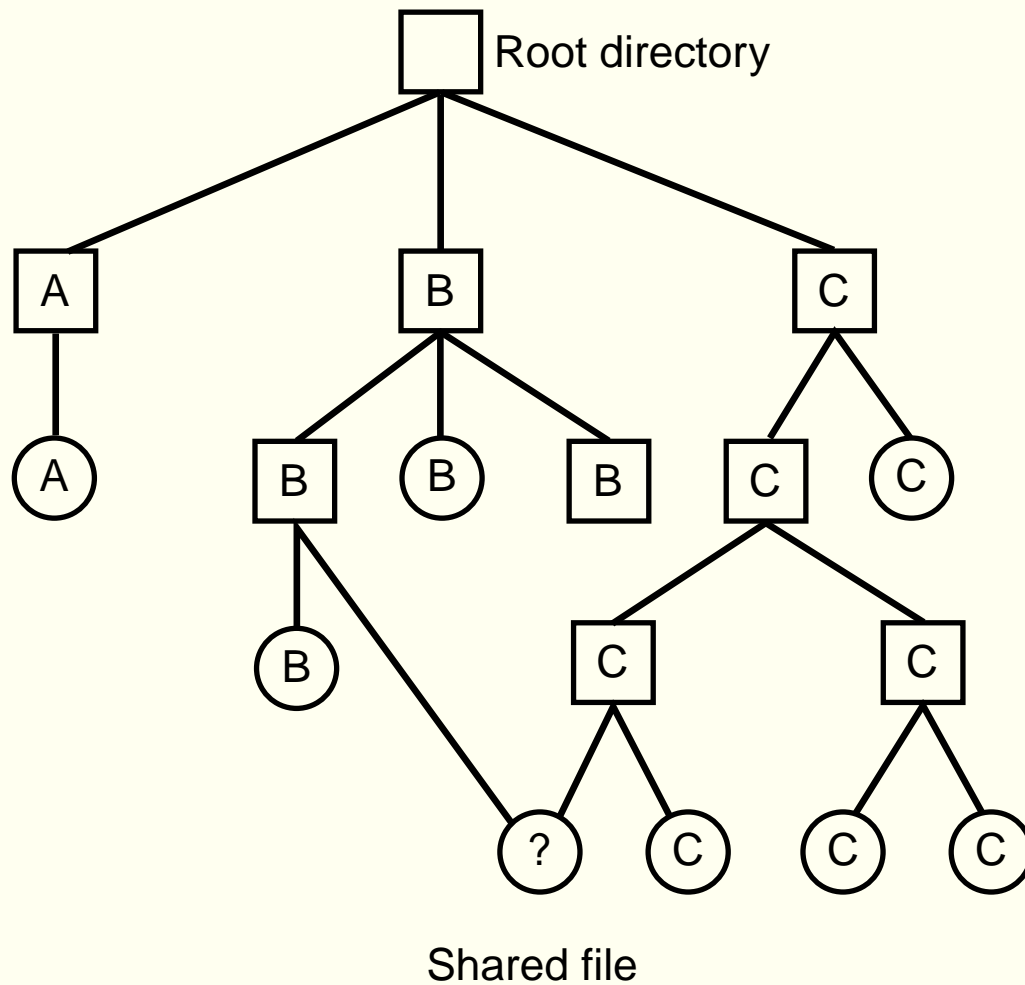

Arquivos compartilhados

C' s directory

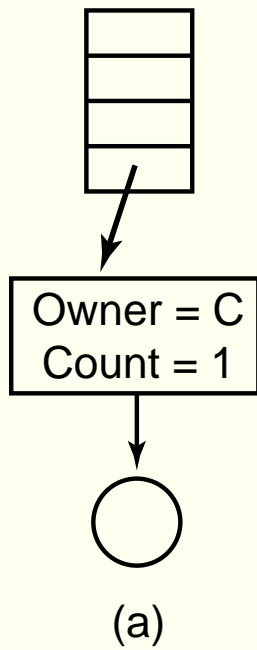

B' s directory C' s directory

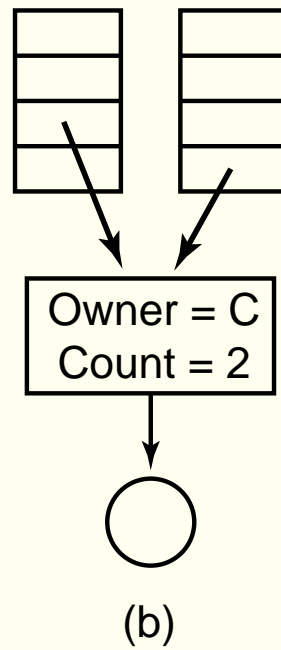

B' s directory

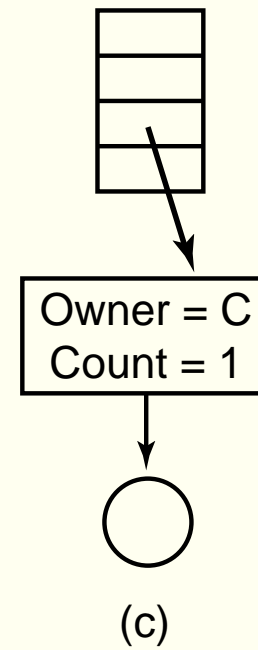

Lista de livres e bitmaps

Free disk blocks: 16, 17, 18

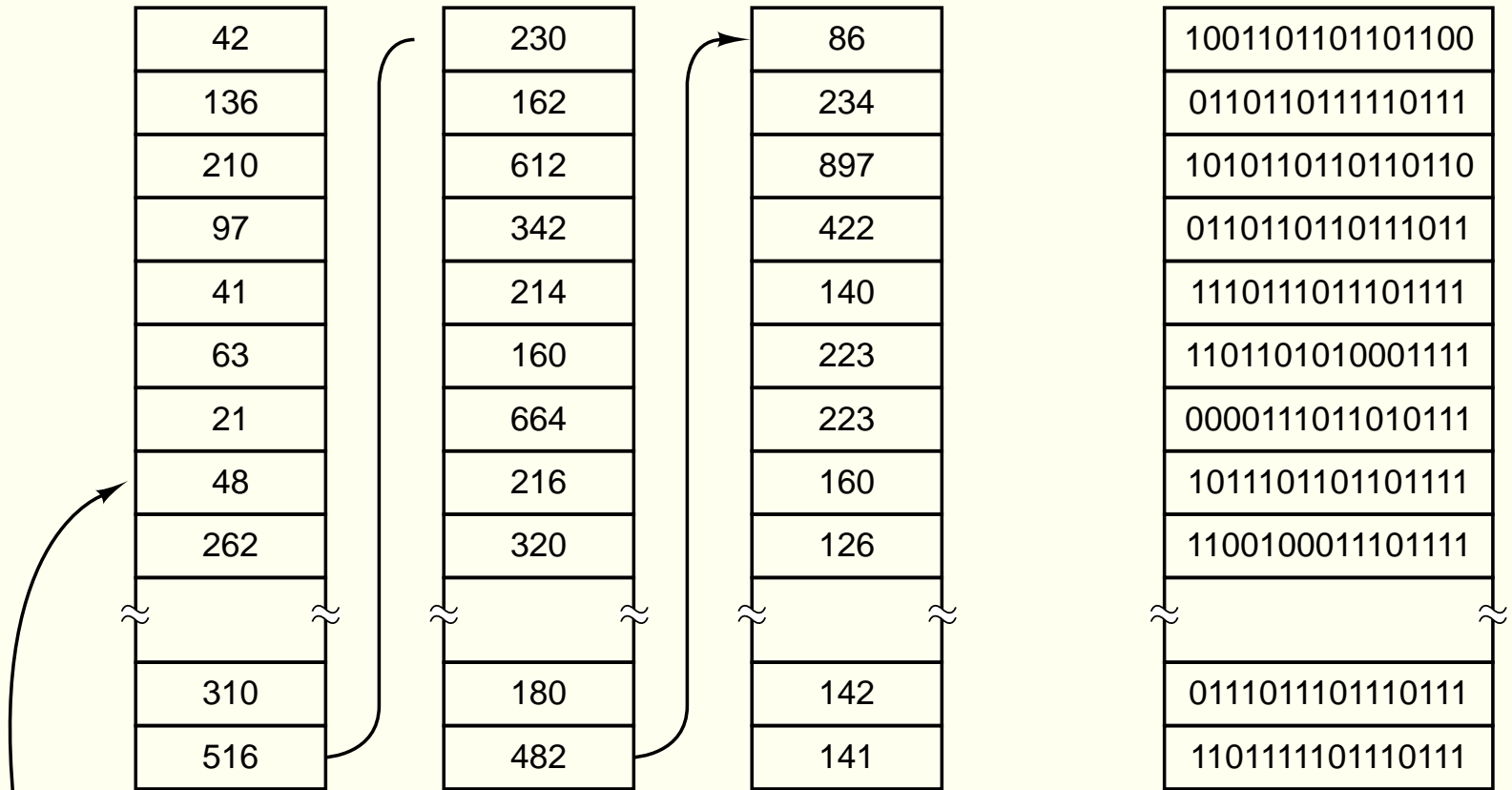

A 1-KB disk block can hold 256
32-bit disk block numbers

(a)

A bitmap

(b)

Bitmaps e lista de livres

Gerência de memória

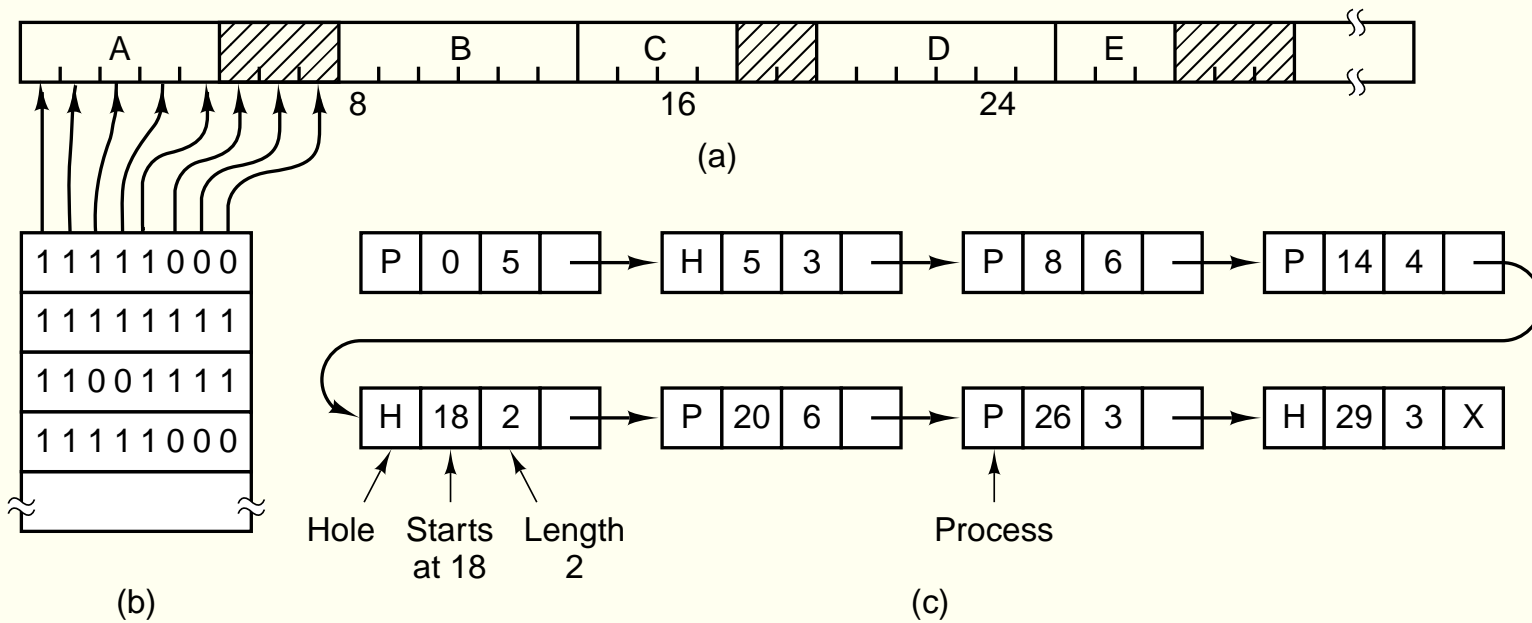

Lista de livres em memória

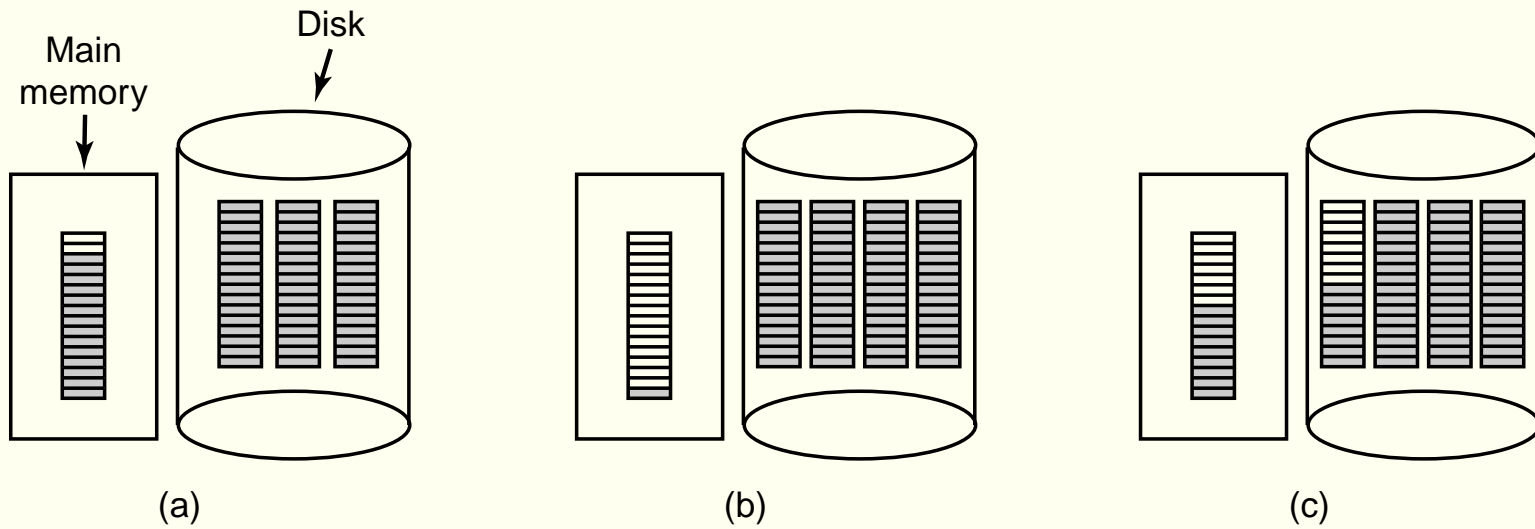

Gerência de quotas

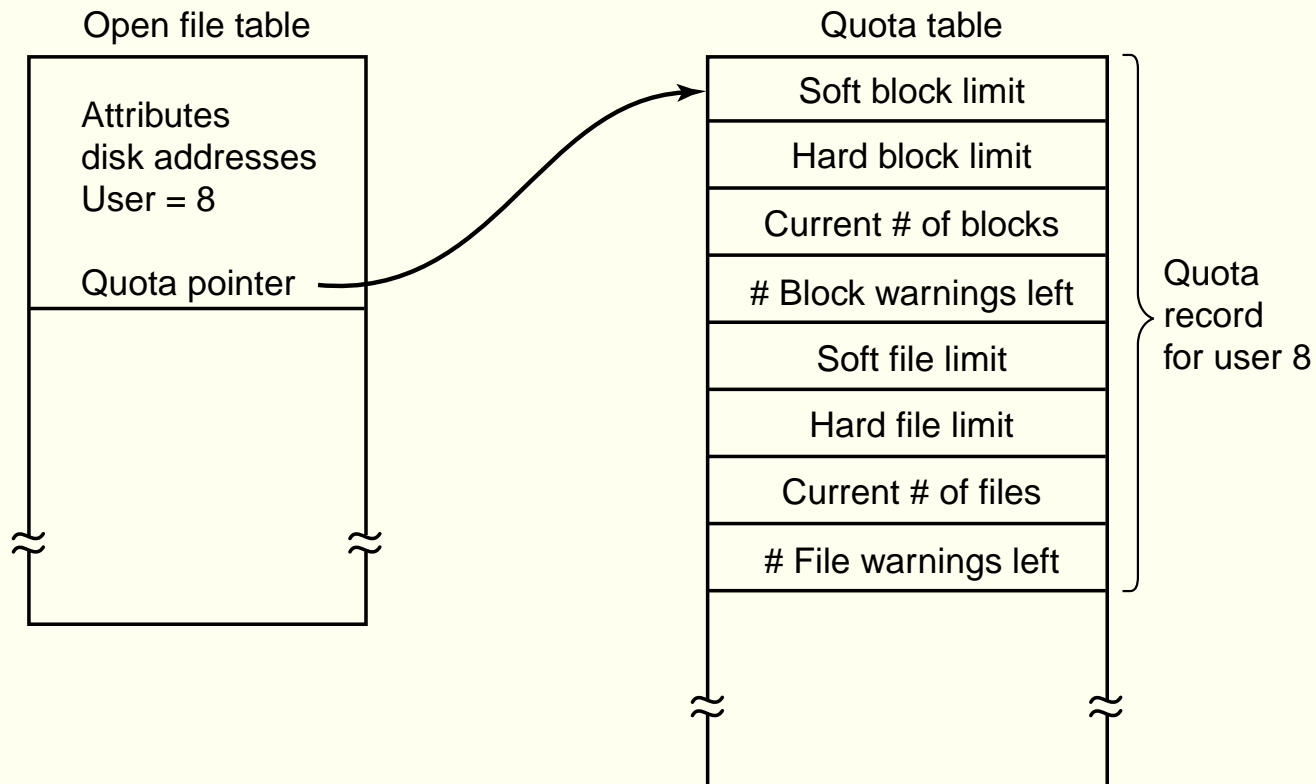

Consistência do sistema de arquivos

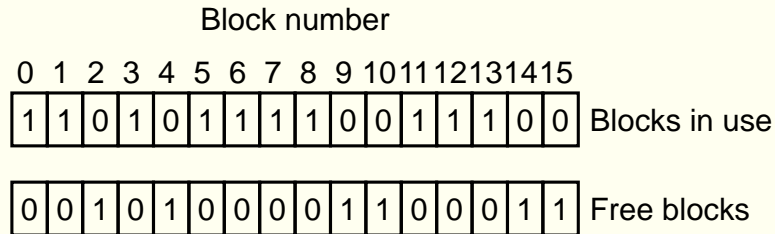

(a)

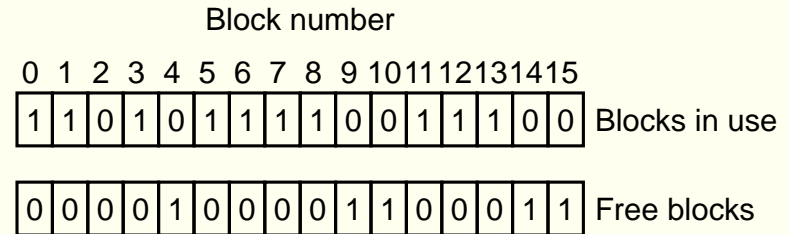

(b)

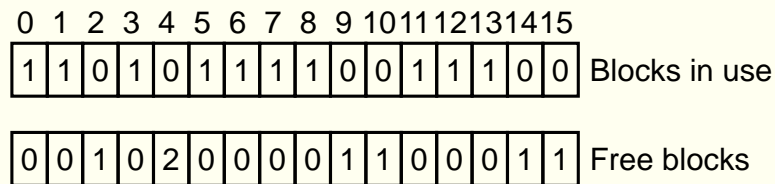

(c)

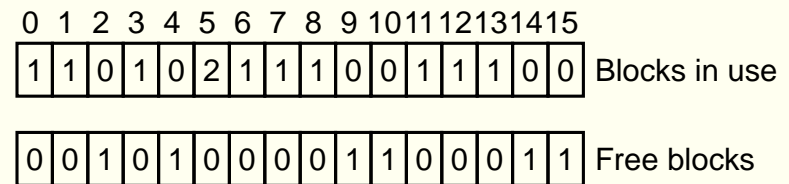

(d)

(a) consistente

(b) bloco faltando

(c) duplicação na
lista de livres

(d) duplicação nos
dados

Consistência do sistema de arquivos

C' s directory

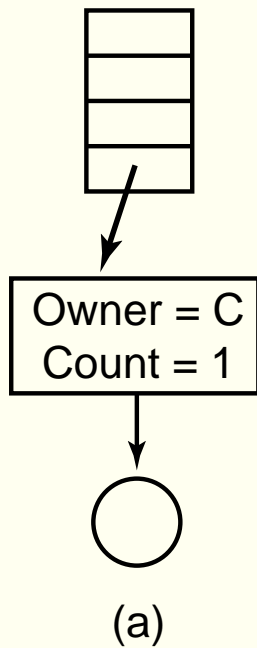

B' s directory C' s directory

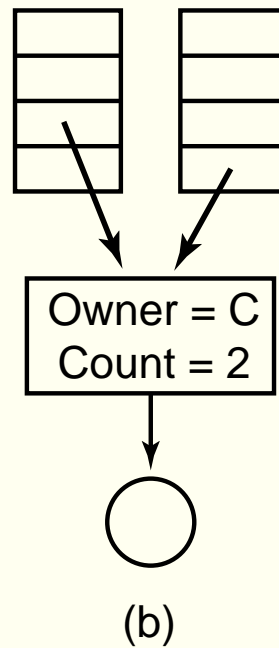

B' s directory

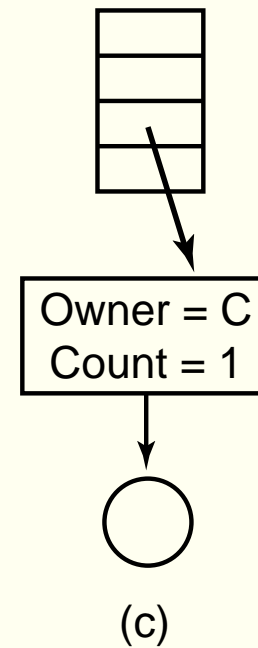

Caching

